



TRELLEBORG

Engineered for the extreme

**PREMIUM SOLID TIRES FOR
THE CONSTRUCTION INDUSTRY**



The Trelleborg Construction Series

The Construction Series by Trelleborg is a range of tires, tracks and wheels built for the most demanding construction environments on earth. Engineered for the extreme, our products are field-tested to ensure they meet the demands of the industry and provide an excellent total value of ownership. Premium compounding and advanced tire design combine to create products that last longer and help reduce downtime. The Trelleborg Construction Series delivers value by maximizing machine productivity and efficiency.

PREMIUM SOLID CONSTRUCTION TIRES: THE TRELLEBORG BRAWLER SERIES

Engineered for the Extreme the Trelleborg Brawler Series provides excellent performance.

Designed for the Extreme

Application-specific features including steel base rings give strength and flexibility to handle excessive torque and high loads of up to 40% more than pneumatic tires. The Solidflex technology with its elliptical apertures provides a comfortable ride and helps to reduce equipment and operator fatigue.

Tested to the Extreme













Working on the world's toughest jobs with the world's toughest machines, Brawler tires are OEM approved on a range of wheel loaders, skid steer loaders, telehandlers, boom lifts, trencher and compact tractors. Brawler tires perform in extreme environments including construction and demolition sites, waste management and underground mining.

Driven to the Extreme

Brawler tires are rigorously tested to ensure maximum performance even under heavy load. Brawler's solid construction and durable cut-resistant compound eliminates downtime caused by punctures and tire damage.



TRELLEBORG PROVIDES SOLUTIONS FOR:

VEHICLE TYPE		PRODUCT RANGE	
 Wheel Loaders	 Backhoes	Brawler HPS & HD	
 Skid Steer Loaders	 Backhoes	Brawler HPS & HD	
 Telehandlers		Brawler HPS	
 Boom Lift		Brawler HD	
 Wheeled Excavator		Trelleborg Excavator	

Brawler HD Solidflex Smooth

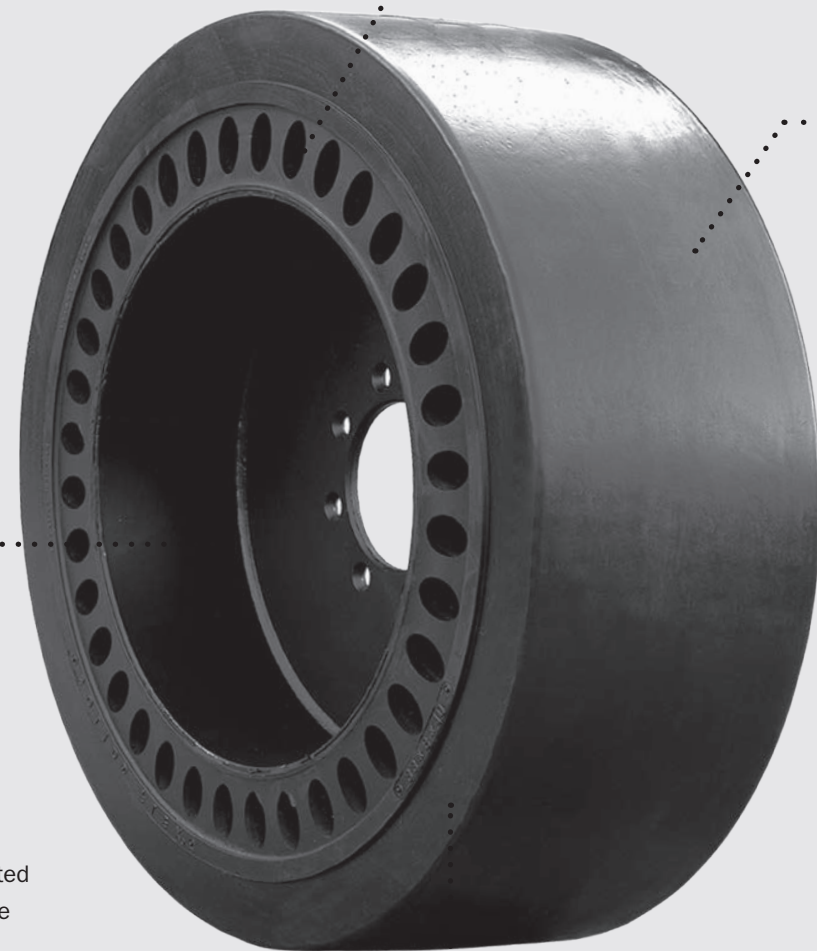

WHEEL AND DISK SYSTEM

Brawler HD tires feature a two-piece patented wheel and disk system that allows easy tire and wheel interchangeability.



TREAD DESIGN

Available in smooth. Custom traction available up to 7 inches deep.



ELLIPTICAL APERTURES

Elliptical apertures provide a softer ride comparable to a foam-filled pneumatic tire, reducing equipment and operator fatigue.



CUT-RESISTANT COMPOUND

Premium tread rubber compound engineered for high abrasion application and superior tire life, with greater resistance to cutting and chunking.



TREAD DESIGN

Deep, self-cleaning step lugs provide excellent traction even on dirt, sand, mud and gravel.



Brawler HPS Skid Steer Solidflex Traction

Brawler HPS Loader



Brawler HPS (High Performance Solid) tires are designed to perform in extreme environments including scrap metal recycling, waste transfer stations and mining operations.

- Up to 3 times more wearable rubber than pneumatic tires
- Fits OEM wheels
- Elliptical apertures deliver a comfortable ride

HPS Solidflex Traction HPS Solidflex Smooth HPS Smooth

Tire Size	Tire Overall Diameter in	Width in	Tread Depth 32nds	Tire Weight lbs	Load Capacity @6 mph lbs
BRAWLER® HPS SOLIDFLEX TRACTION					
17.5x25	52.8	17.6	195/32	1,145	19,410
20.5x25	58.9	20.7	237/32	1,749	26,795
23.5x25	64.2	23.9	272/32	2,448	33,775
26.5x25	67.5	28.3	297/32	3,252	40,335
29.5x25	72.6	30.0	333/32	4,076	49,690
BRAWLER® HPS SOLIDFLEX SMOOTH					
17.5x25	52.8	17.6	195/32	1,215	19,410
20.5x25	58.9	20.7	237/32	1,812	26,795
23.5x25	64.2	23.9	272/32	2,529	33,775
26.5x25	67.5	28.3	297/32	3,375	40,335
29.5x25	72.6	30.0	333/32	4,233	49,690
BRAWLER® HPS SMOOTH					
17.5x25	52.8	17.6	195/32	1,239	25,830
20.5x25	58.9	20.7	237/32	1,836	35,735
23.5x25	64.2	23.9	272/32	2,571	45,030
26.5x25	67.5	28.3	297/32	3,426	53,770
29.5x25	72.6	30.0	333/32	4,300	66,250

Brawler HD Loader



Brawler HD tires are designed to perform in extreme environments where good ride quality is required including scrap metal recycling centers, waste transfer stations and mining operations. The Brawler HD features a two-piece patented wheel and disk system that allows tire and wheel interchangeability by simply changing the disk.

- Elliptical apertures provide a softer ride than foam-filled pneumatic tires
- Steel wheels engineered to handle heavy loads, excessive torque, severe shear and bending stress
- Custom traction tread available up to 7 inches deep
- Up to 3 times more wearable rubber than pneumatic tires

HD Smooth HD Solidflex Smooth

Tire Size	Pneumatic Equivalent Size	Tire Overall Diameter in	Width in	Rubber Thickness in	Tread Depth 32nds	Tire Weight lbs	Load Capacity @6 mph lbs
BRAWLER® SOLIDFLEX							
55x10x18	17.5x25	55.0	18.0	10.0	160/32	1,499	29,420
59x12x20.5	20.5x25	59.0	20.5	11.5	208/32	2,172	34,790
62x13x21	20.5x25	62.0	21.0	13.0	241/32	2,396	36,960
66x16x24	23.5x25	66.0	24.0	16.0	320/32	3,231	43,110
69x17x28	26.5x25	69.0	28.0	17.0	351/32	4,105	52,240
73x18x31	29.5x25	73.0	31.0	17.7	384/32	5,010	59,855
80x18x35	35/65-33	80.0	35.0	18.0	384/32	7,200	78,045
BRAWLER® HD							
55x10x18	17.5x25	55.0	18.0	10.0	160/32	1,478	22,070
59x12x20.5	20.5x25	59.0	20.5	11.5	208/32	1,967	26,090
62x13x21	20.5x25	62.0	21.0	13.0	240/32	2,273	27,725
66x16x24	23.5x25	66.0	24.0	16.0	320/32	3,044	32,330
69x17x28	26.5x25	69.0	28.0	17.0	352/32	3,867	39,175
73x18x31	29.5x25	73.0	31.0	17.7	384/32	4,726	44,885
80x18x35	35/65-33	80.0	35.0	18.0	384/32	7,200	58,535

Brawler HD Skid Steer



Brawler Skid Steer tires are designed to eliminate downtime and provide superior performance in severe-duty applications. They feature an enhanced rubber compound designed for greater resistance to cutting and chunking. Trelleborg manufactures Solidflex tires that feature elliptical apertures and HD tires that are aperture free.

- Durable cut-resistant rubber compound eliminates downtime caused by tire damage
- No specialized equipment required to install
- Passed the rigorous testing of many major OEMs

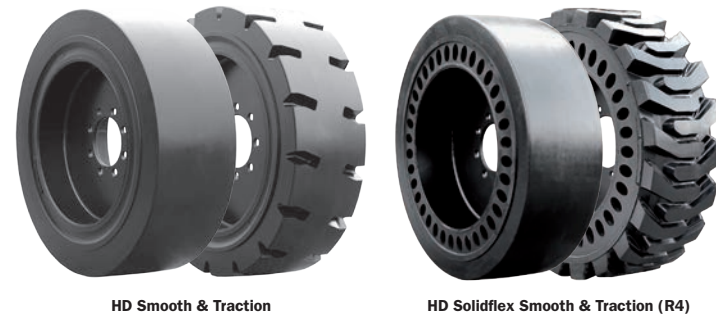

Tire Size	Pneumatic Equivalent Size	Tire Overall Diameter in	Width in	Rubber Thickness in	Tread Depth Traction 32nds	Tire Weight lbs	Load Capacity @6 mph lbs	Tread
BRAWLER® SOLIDFLEX SMOOTH & TRACTION								
31x6x10	10-16.5	31.0	10.0	6.2	60/32	230	6,615	R4
33x6x11	12-16.5	33.0	11.0	6.1	77/32	281	7,935	R4
36x7x11	14-17.5	36.0	11.0	6.6	89/32	342	8,565	R4
33x6x8	8.00-16	33.0	8.0	6.1	77/32	257	5,510	SM
31x5x9	10-16.5	31.0	9.0	5.1	77/32	253	5,910	SM
33x6x10	12-16.5	33.0	10.0	6.1	77/32	290	7,365	SM
BRAWLER® HD SMOOTH & TRACTION								
31x5x7	7.50-16	31.0	7.0	5.2	48/32	190	5,410	TR
31x5x7	7.50-16	31.0	7.0	5.2	48/32	190	5,410	SM
33x6x8	8.00-16	33.0	8.0	6.1	58/32	258	6,340	TR
33x6x8	8.00-16	33.0	8.0	6.1	77/32	263	6,340	SM
31x5x9	10-16.5	31.0	9.0	5.2	49/32	265	7,230	TR
31x5x9	12-16.5	31.0	9.0	5.2	93/32	245	7,230	SM
33x6x10	12-16.5	33.0	10.0	6.1	58/32	311	8,170	TR
33x6x10	12-16.5	33.0	10.0	6.1	77/32	320	8,165	SM
36x7x11	14-17.5	36.0	11.0	6.7	147/32	420	9,330	SM
40x9x13	15-19.5	40.0	13.0	8.7	211/32	640	11,210	SM

Brawler HPS Skid Steer



Brawler HPS (High Performance Solid) Skid Steer tires are designed to perform in extreme environments including scrap metal recycling, waste transfer stations and mining operations. The Brawler HPS Solidflex features elliptical apertures to deliver a comfortable ride resulting in reduced equipment and operator fatigue.

- Durable cut-resistant rubber compound eliminates downtime caused by tire damage
- Deep lug tread design offers 3 times more wearable rubber than a pneumatic tire
- Conveniently fits one wheel size (7.5x20)*

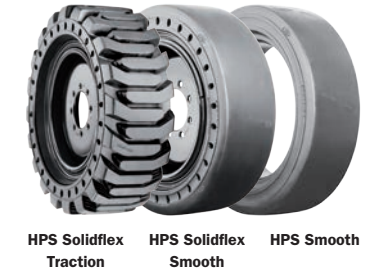

Tire Size	Pneumatic Equivalent Size	Tire Overall Diameter in	Width in	Tread Depth 32nds	Tire Weight lbs	Load Capacity @6 mph lbs
BRAWLER® HPS SOLIDFLEX TRACTION TIRES						
31x10-20	10-16.5	31.0	10.0	52/32	170	6,205
33x12-20	12-16.5	33.0	11.2	71/32	215	6,550
36x14-20	14-17.5	36.0	14.0	89/32	318	7,295
40x14-20	15-19.5	40.0	14.0	118/32	415	10,925
BRAWLER® HPS SOLIDFLEX SMOOTH TIRES						
31x10-20	10-16.5	31.0	10.0	52/32	176	6,205
33x12-20	12-16.5	33.0	11.2	71/32	229	6,550
36x14-20	14-17.5	36.0	14.0	89/32	341	7,295
40x14-20	15-19.5	40.0	14.0	118/32	462	10,925
BRAWLER® HPS SMOOTH TIRES						
31x10-20	10-16.5	31.0	10.0	52/32	174	8,280
33x12-20	12-16.5	33.0	12.0	71/32	234	8,730
36x14-20	14-17.5	36.0	14.0	89/32	355	9,735
40x14-20	15-19.5	40.0	14.0	118/32	477	14,560

*All except 40x14-20/10

Brawler HPS Telehandler



Brawler HPS (High Performance Solid) Telehandler tires are designed to perform in demanding environments. The wide, flat tread design provides excellent stability and the counter-weight required by telehandlers on rough terrain. The Solidflex design features patented elliptical apertures to deliver a comfortable ride prolonging operating time for equipment, which results in reduced equipment and operator fatigue.



Tire Size	Tire Overall Diameter in	Section Width in	Tread Depth in	Load Capacity @6 mph lbs	Load Capacity @16 mph lbs	Tire Weight lbs
BRAWLER® HPS SOLIDFLEX						
13.00-24	51.0	13.0	129/32	13,085	10,440	670
14.00-24	53.0	14.0	141/32	14,780	11,800	815

Brawler HD Boom Lift



Brawler HD tires are designed and engineered to provide superior stability and safety for Aerial Work Platform applications.

FEATURES AND BENEFITS

- Maintenance free – no worries about flats or downtime
- Low-profile tire enhancing center of gravity
- Elliptical apertures that provide a pneumatic type ride without the bounce
- Premium mining rubber compound, which is more resistant to cuts and chunks

APPLICATIONS

- Telescopic Booms
- Mobile Cranes
- Scissor Lifts



HD Solidflex Traction

Tire Size	Pneumatic Equivalent	Tire Overall Diameter in	Section Width in	Rubber Thickness in	Tread Depth 32nds	Load Capacity 6mph lbs	Weight lbs
HD SOLIDFLEX TRACTION							
43x6x14.5	385/65D22.5	43.0	14.5	14.49	66	14,695	644
46x6x18	445/65D22.5	46.5	17.76	17.76	66	20,030	840

Trelleborg Excavator



Trelleborg Excavator tires offer excellent traction and stability through their innovative tread design and construction while keeping machine downtime to a minimum by eliminating punctures. This tire delivers superb performance in environments where safety is paramount and downtime unacceptable.

The Trelleborg Excavator range is ideal for use in the construction, waste management and timber industries.



Excavator

Size	Rim	Pattern	Tire Overall Diameter in	Section Width in	Static Load lbs	Load Capacity 6mph lbs	Weight lbs
EXCAVATOR							
10-20	7.00-20	Excavator	39.6	9.4	16,645	12,015	314
10-20	8.5-20	Excavator	43	10.2	20,975	15,135	415

Rubber Cutting Edges

Brawler Rubber Cutting Edges are engineered for lasting performance. The shape, design and premium mining rubber compound extends the life of the edge. Our unique patented T-shaped fastener system fits most bucket sizes. Available in 3 length options: 36", 40" and 48".

- Premium mining rubber compound that is abrasion and chunk resistant
- Enhanced shape increases service life
- 6" Rubber thickness
- 2" Tapered edge to aid in scraping low loads and to protect flooring





Trelleborg is a world leader in engineered polymer solutions that seal, damp and protect critical applications in demanding environments. Our innovative engineered solutions accelerate performance for customers in a sustainable way. The Trelleborg Group has local presence in over 40 countries around the world.